

5 59 837 0110 0

eibe minimundo
Instalación de juego
Familia elefante







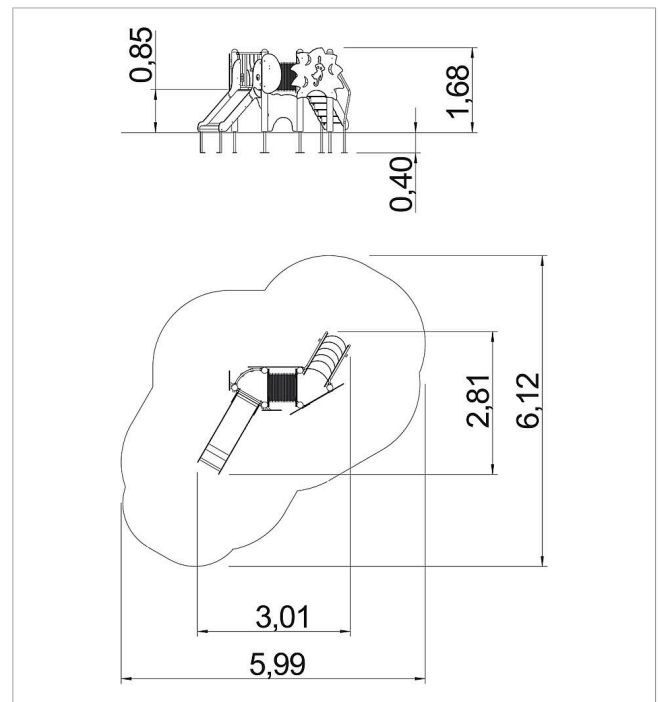

made in germany



Volumen del suministro

- Tobogán: HPL, acero inoxidable
- Escalera: HPL, acero inoxidable
- Elemento de valla: acero inoxidable, PE
- Tubo para gatear: PP, HPL
- Juego de plataformas: HPL
- Placa jungla: HPL
- Placa elefantito: HPL
- Juego de orejas elefante: HPL
- Juego de postes con pies de soporte: madera de conífera, acero galvanizado en caliente



	Material	Madera de conífera con impregnación en autoclave
	Nivel fundamento	FL 1
	Espacio mínimo	612x599x265 cm
	Altura de caída libre	85 cm
	Prot. contra caídas neto	25 m ²
	Fundamentos	4x FHS o 2x FPP + 6x FPR
	Montaje	2 personas/6 h
	Pieza más grande	2150x490x700 cm
	Pieza más pesada	80 kg