

5 45 144 0530 6







**eibe paradiso**  
**Estructura juego de**  
**agua Farlon**  
made in germany

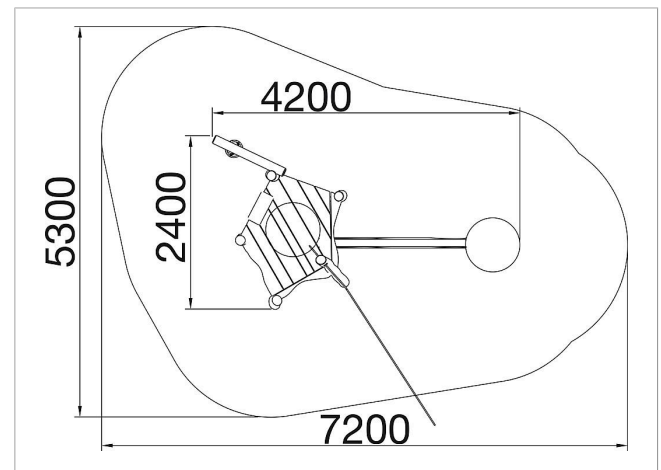

**Volumen del suministro**

- 1x plataformas: robinia
- 1x elevador de arena: acero inoxidable
- 1x bomba con conexión directa de agua: fyción gris
- 2x canales de agua: robinia
- 1x tamiz de arena: acero inoxidable
- 2x cubas de madera: robinia
- 1x juego de postes: robinia



	Material	Robinia
	Nivel fundamento	FL 3
	Espacio mínimo	7,2x5,3 m
	Altura de caída libre	45 cm
	Prot. contra caídas neto	ca. 35 m <sup>2</sup>
	Fundamentos	6x FHS