

5 59 844 0110 0

made in germany







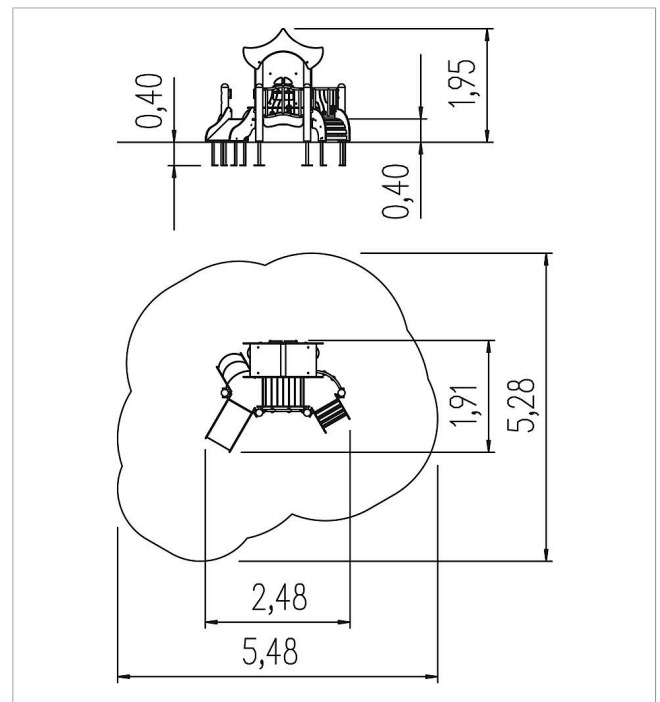

1+

### Volumen del suministro

tejado: HPL  
banco de sentar: HPL  
Wandelement mit Fenster und Läden: HPL, acero inoxidable  
tobogán: HPL  
rampa en forma de arco: Madera de conífera, HPL  
escalera: HPL  
plataforma: HPL, Madera de conífera  
juego de elementos valla: acero inoxidable, PE  
Bases para postes:  
Madera de conífera, acero galvanizado en caliente



	Material	Madera de conífera impregnado en autoclave
	Nivel fundamento	FL 1
	Espacio mínimo	548x528x220 cm
	Altura de caída libre	40 cm
	Prot. contra caídas neto	22,5 m <sup>2</sup>
	Fundamentos	1xFHS oder 5xFPP+4xFPR
	Pieza más grande	110x94x25,5 cm