

5 55 097 5







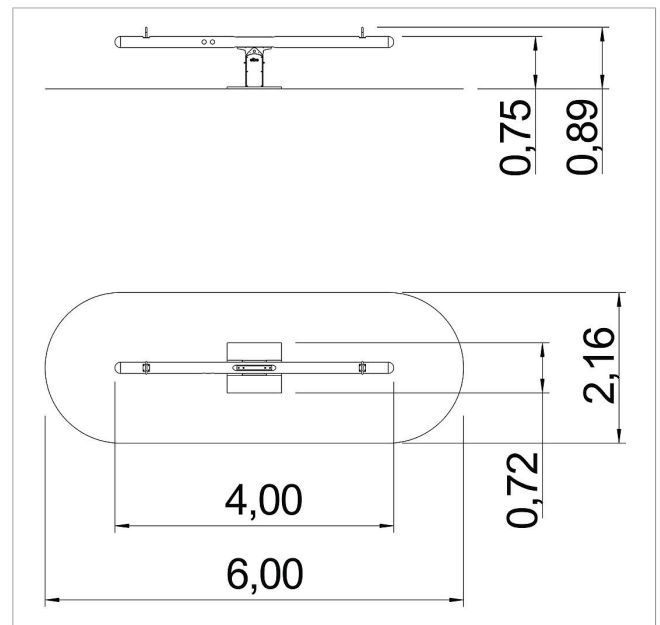

**eibe ibondo Balancín
con amortiguación de
golpes**
made in germany

3+

Volumen del suministro

- 1 viga de balancín: madera de conífera con impregnación en autoclave
- 2 asas de sujeción: acero recubierto en polvo
- 1 pie para balancines: acero galvanizado en caliente, acero inoxidable, HPL
- 2 placas laterales de absorción de impactos



	Material	Madera de conífera con impregnación en autoclave
	Nivel fundamento	FL 3
	Espacio mínimo	600x216x305 cm
	Altura de caída libre	125 cm
	Prot. contra caídas neto	12 m ²
	Fundamentos	1x FHS
	Montaje	2 personas/2 h
	Pieza más grande	400xØ 16 cm
	Pieza más pesada	60 kg