

5 67 233 0

**eibe ibondo Balancín
de muelle múltiple
delfines y ballenas**





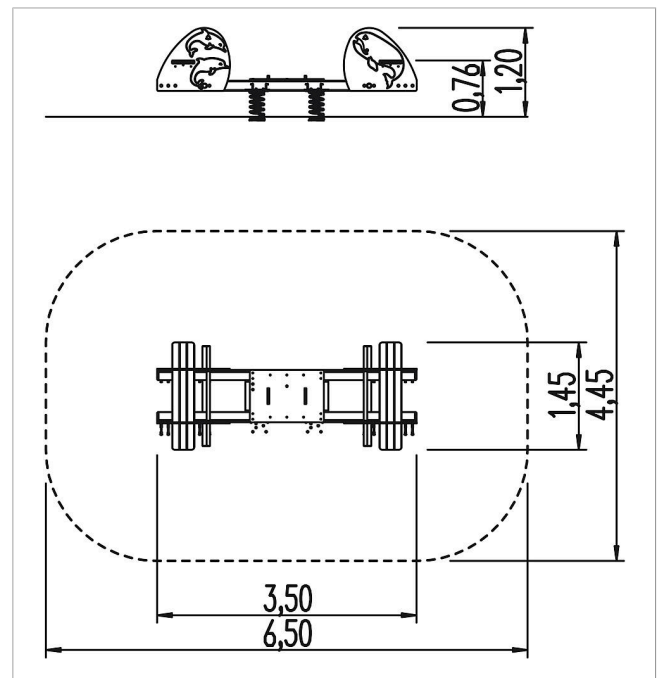

made in germany

3+

Volumen del suministro

1 cuerpo de animal con muelle: MC con impregnación en caldera de presión, HPL
4 muelles: acero para muelles



	Material	Madera de conifera con impregnación en autoclave
	Nivel fundamento	FL 3
	Espacio mínimo	650x445x278 cm
	Altura de caída libre	100 cm
	Prot. contra caídas neto	26,5 m ²
	Fundamentos	4x 5632280 + 4x FHS
	Montaje	2 personas/1,5 h
	Pieza más grande	350x130x89 cm
	Pieza más pesada	110 kg