

5 25 074 0110 0

eibe unique Instalación de juego Dantos, Solo







made in germany

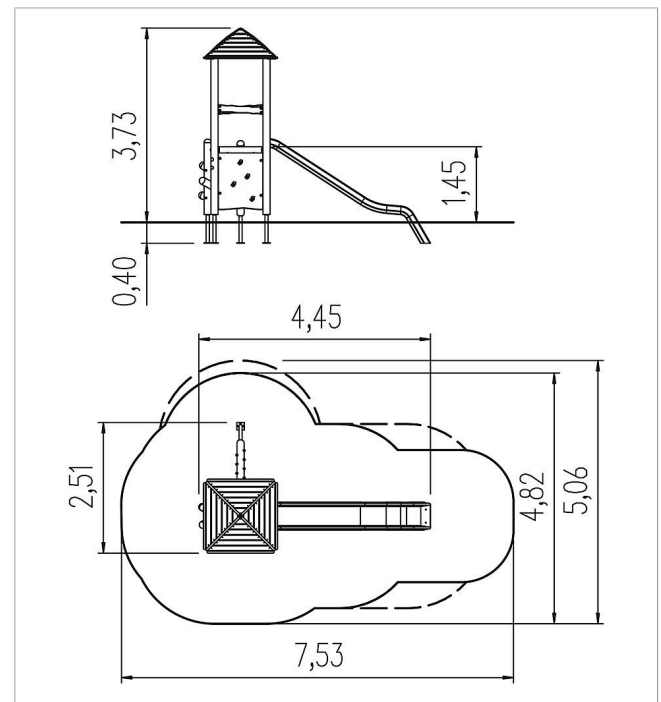

Volumen del suministro

- Construcción de postes: madera de conífera
- Bases de postes: acero galvanizado en caliente
- Construcción de plataforma: acero galvanizado en caliente, HPL
- 1 tejado: MadC
- 1 pared de escalar con asas: HPL, GFRP
- 1 subida escalante de tronco: MadC
- 1 subida de tronco: MadC
- 1 panel de entrada: HPL



	Material	MadCAc
	Nivel fundamento	FL 1
	Espacio mínimo	753x506x373 cm
	Altura de caída libre	145 cm
	Prot. contra caídas neto	25,5 m ²
	Fundamentos	7x FHS oder 7x FPP