

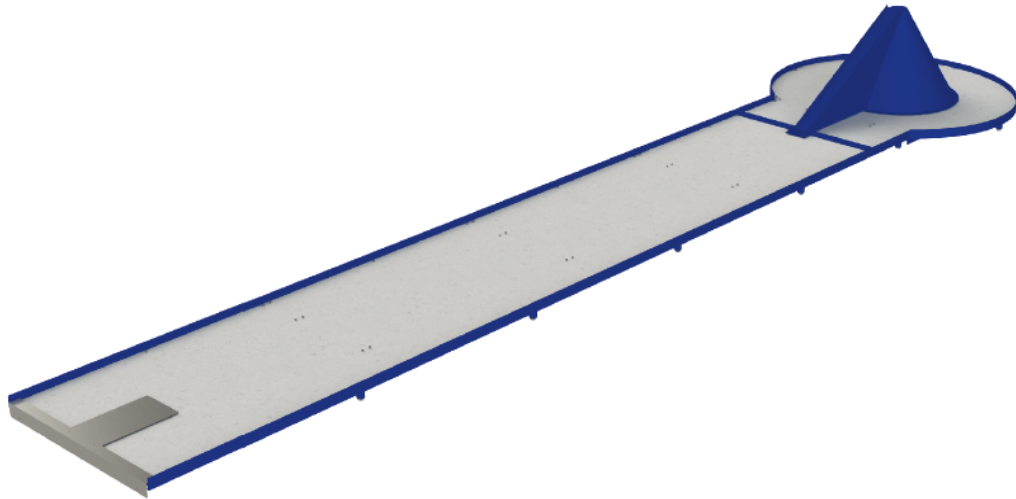

## EDMGV003 VOLCÁN



+4 AÑOS



0 m

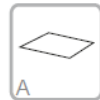

20 m<sup>2</sup>

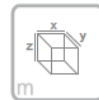

x= 6,23  
y= 1,40  
z= 0,58

Ficha Técnica

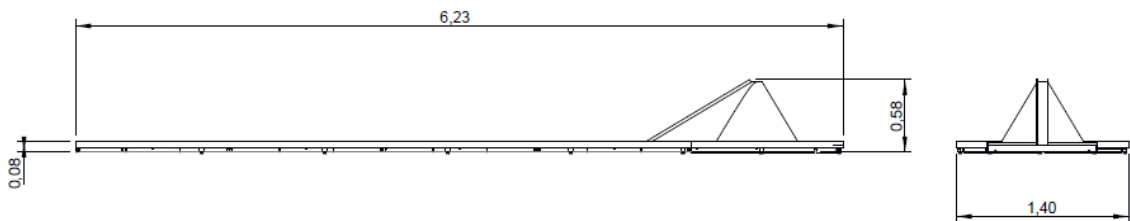

El uso del equipo en condiciones controladas:  
Zona de seguridad: Área mínima requerida por EN 1176-1,3,7;

GB.047.01



## Información Equipo:

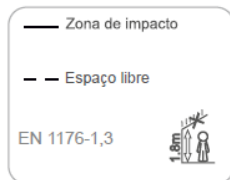

.....	1
	0
	20
	20

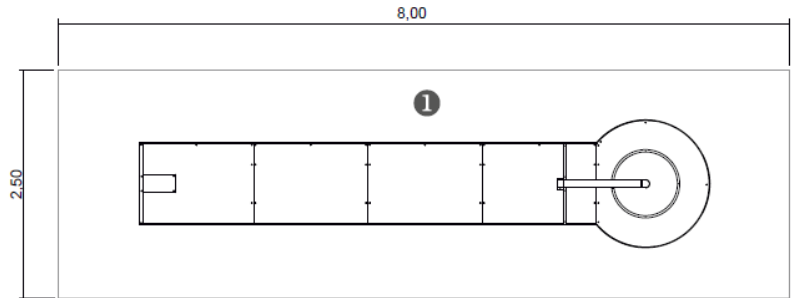

## Información Técnica:

1 - Mini-Golfe Vulcão

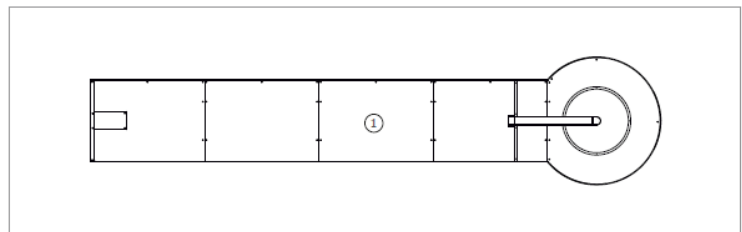



## Características Técnicas:

### Estructura

**Chapa de Hierro:** Electrocinchado y lacado el gel esmalte a 230 ° C, con un espesor de 50 a 70µm, según la norma UNE EN ISO 2808;

### Sistema de fijación:

**Tipo B - Sistema de fijación** standard se compone de metal común atornillada al suelo con casquillos de metal;

### Tornillería y accesorios

**Tornillos:** Acero galvanizado o opcionalmente AISI 304 de acero inoxidable;

**Opcional:** Base con césped sintético de fibra de polipropileno, la altura de 6 mm, color verde, 98.500 pontos/m<sup>2</sup>, densidad de 2.200 dtex y resistente los rayos UV (ref.: EDMG003);



100% reciclable;



Base con césped sintético

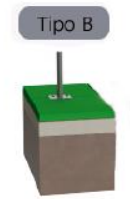

Sistema de Fijación

## Funciones Lúdicas:



**Juego:** Desarrolla la paciencia, el compartir y el espíritu deportivo.