

5 59 839 0110 0







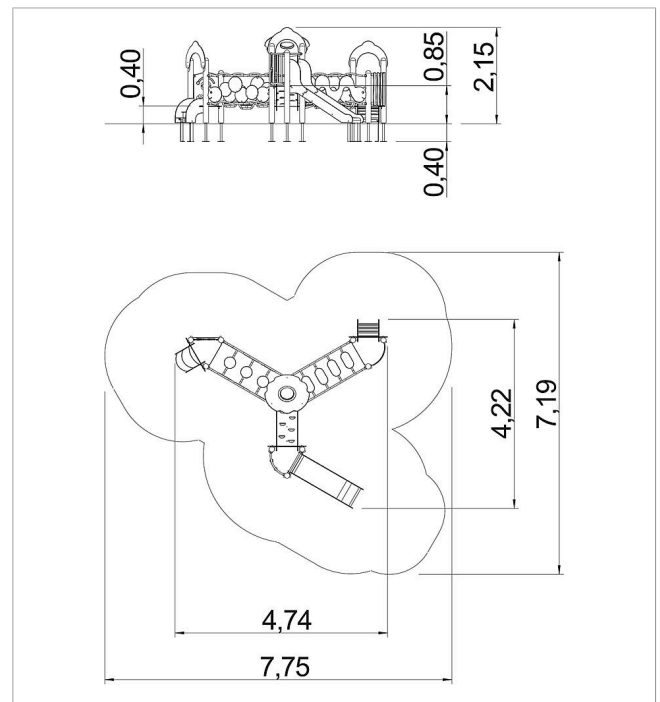

eibe minimundo
Instalación de juego
Hiedra
made in germany



Volumen del suministro

Tobogán: HPL, acero inoxidable
 Escalera: HPL
 Elemento de valla: acero inoxidable, PE
 Elemento de valla algas: acero inoxidable, HPL
 Juego de niveles de plataforma: HPL
 Subida de peldaños: HPL, fresno
 Tejado: HPL, Makrolon
 Subida: HPL
 Juego de arcos: HPL
 Baranda espejo: HPL, PU, plexiglás
 Pasaje serpiente: acero inoxidable, HPL
 Pasaje gusano: acero inoxidable, HPL
 Juego de postes con pies de soporte: madera de conífera, acero galvanizado en caliente



	Material	Madera de conífera con impregnación en autoclave
	Nivel fundamento	FL 1
	Espacio mínimo	775x719x265 cm
	Altura de caída libre	85 cm
	Prot. contra caídas neto	39,5 m ²
	Fundamentos	5x FHS o 5x FPP + 8x FPR
	Montaje	2 personas/7 h
	Pieza más grande	2150x490x700 cm
	Pieza más pesada	80 kg