

5 25 030 0110 0

**eibe unique Columpio
doble Águila con
asiento de nido**







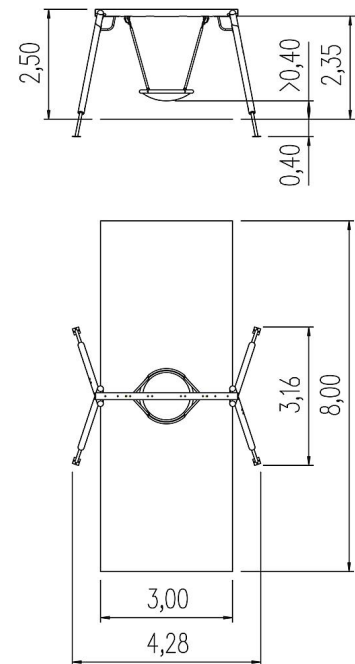

made in germany

3+

Volumen del suministro

1 armazón de columpio: madera de conífera, acero galvanizado en caliente
1 asiento de nido Ø 120 cm: anillo de cuerda, tejido de goma encima de cadenas, juego de articulaciones: acero galvanizado en caliente
Bases de postes: acero galvanizado en caliente



	Material	Madera de conífera con impregnación en autoclave
	Nivel fundamento	FL 1
	Espacio mínimo	800x428x383 cm
	Altura de caída libre	200 cm
	Prot. contra caídas neto	24 m ²
	Fundamentos	4x FHS oder 4x FPP + 4x FHS
	Montaje	2 personas/3 h
	Pieza más grande	338xØ 14 cm
	Pieza más pesada	30 kg