

5 55 090 5

eibe ibondo Balancín de dos plazas







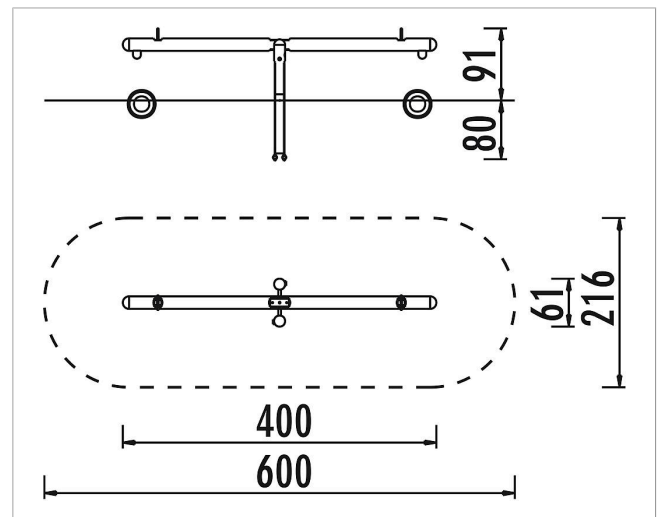

made in germany

3+

Volumen del suministro

- 1 viga de balancín: madera de conífera con impregnación en autoclave
- 2 postes para balancines: madera de conífera con impregnación en autoclave
- 2 asas de sujeción: acero recubierto en polvo
- 2 neumáticos: goma
- Bases para postes: acero galvanizado en caliente



	Material	Madera de conífera con impregnación en autoclave
	Nivel fundamento	FL 3
	Espacio mínimo	600x216x290 cm
	Altura de caída libre	110 cm
	Prot. contra caídas neto	12 m ²
	Fundamentos	1x FHS
	Montaje	2 personas/2 h
	Pieza más grande	400xØ 16 cm
	Pieza más pesada	60 kg