

5 66 508 5

## eibe ibondo Rampa de montañismo Baku

made in germany

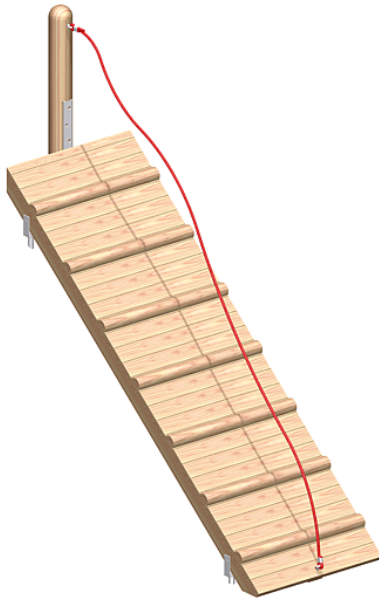

### Volumen del suministro







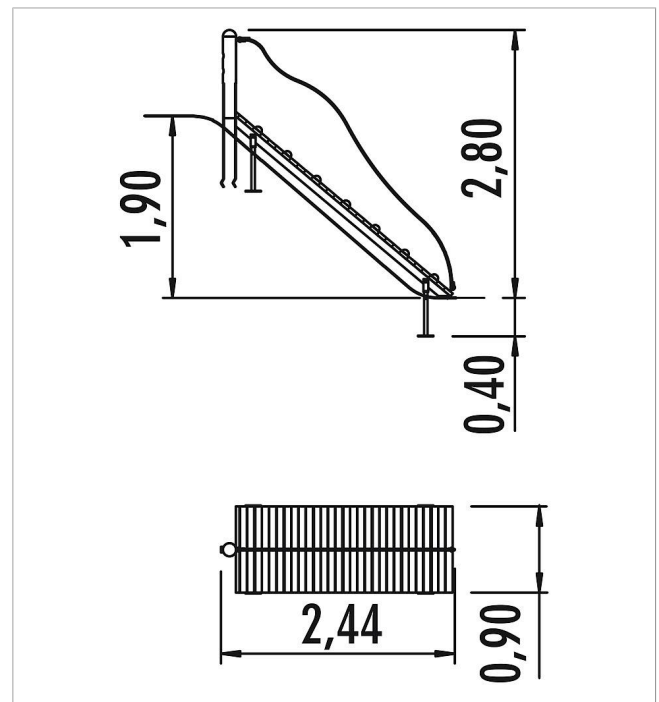

1 rampa de montaña: madera de conífera con impregnación en autoclave

1 poste: madera de conífera con impregnación en autoclave

1 cuerda: cable de acero recubierto con plástico

Bases para postes: acero galvanizado en caliente



	Material	Madera de conífera con impregnación en autoclave
	Nivel fundamento	FL 1
	Espacio mínimo	244x90x370 cm
	Altura de caída libre	-
	Prot. contra caídas neto	-
	Fundamentos	5x FHS o 4x FFP + 1x FHS
	Montaje	2 personas/1 h
	Pieza más grande	292x90x12 cm
	Pieza más pesada	60 kg