

5 55 120 5

## eibe ibondo Barra fija con 2 niveles







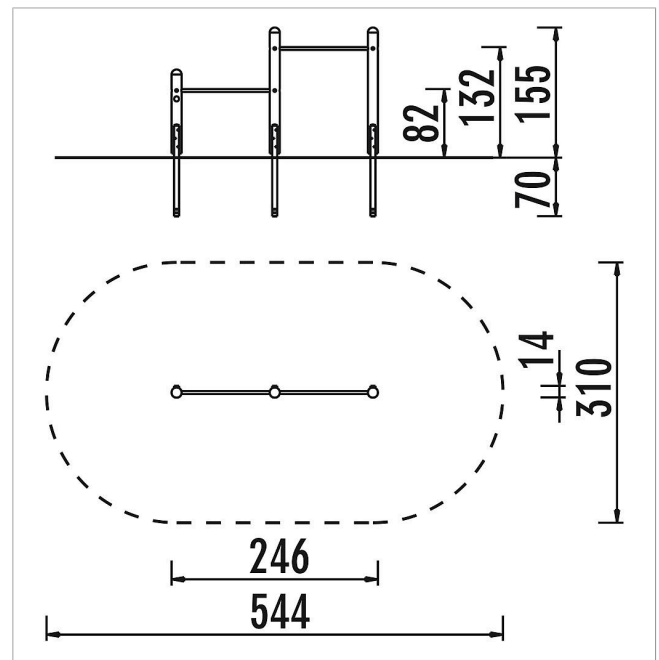

made in germany



### Volumen del suministro

3 postes fijos: madera de conífera con impregnación en autoclave  
2 barras fijas: acero galvanizado en caliente y recubierto en polvo  
Bases para postes: acero galvanizado en caliente



	Material	Madera de conífera con impregnación en autoclave
	Nivel fundamento	FL 3
	Espacio mínimo	544x310x312 cm
	Altura de caída libre	132 cm
	Prot. contra caídas neto	14 m <sup>2</sup>
	Fundamentos	3x FHS
	Montaje	1 persona/1 h
	Pieza más grande	150xØ 12 cm
	Pieza más pesada	15 kg