

5 25 064 0110 0

eibe unique Instalación de juego Uthilos





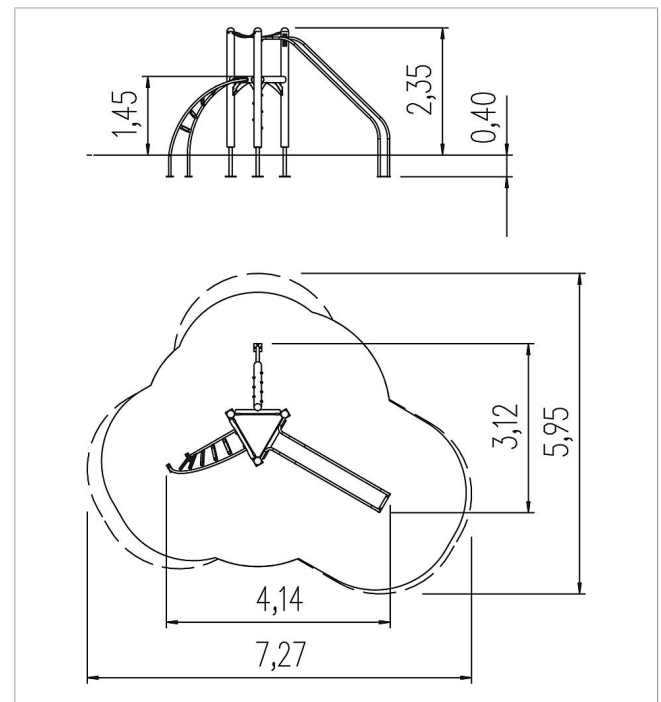

made in germany

6+

Volumen del suministro

Construcción de postes: madera de conífera
Bases de postes: acero galvanizado en caliente
Construcción de plataforma: acero galvanizado en caliente y recubierto en polvo, HPL
1 subida tortuosa: acero inoxidable, robinia
1 tobogán de pasamanos acero inoxidable
1 subida de tronco madera de pino



	Material	MadCAc
	Nivel fundamento	FL 1
	Espacio mínimo	727x597x235 cm
	Altura de caída libre	218 cm
	Prot. contra caídas neto	25,6 m ²
	Fundamentos	6x FHS ó 6x FPP