

5 25 028 0110 0

## eibe unique Instalación de juego Liara







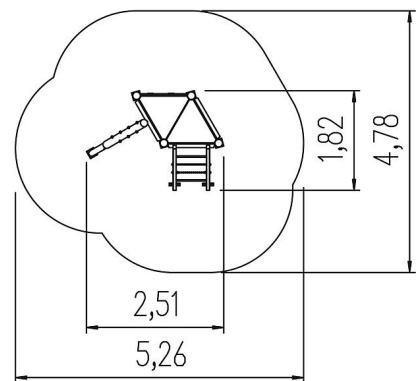
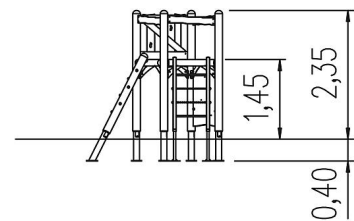

made in germany

3+

### Volumen del suministro

Construcción de postes: madera de conífera  
 Bases de postes: acero galvanizado en caliente  
 Construcción de plataforma: acero galvanizado en caliente y recubierto en polvo, HPL  
 1 balaustrada: madera de conífera  
 1 pared de escalada con asas de sujeción: HPL, GRP  
 1 subida de tronco: madera de conífera  
 1 subida de escalera madera de conífera, cable de acerocable de acero cable de acero recubierto en pl rama ico, acero inoxidable



	Material	MadCAc
	Nivel fundamento	FL 1
	Espacio mínimo	526x478x235 cm
	Altura de caída libre	145 cm
	Prot. contra caídas neto	17,8 m <sup>2</sup>
	Fundamentos	7xFPp o 7xFHS
	Montaje	-
	Pieza más grande	275xø14 cm
	Pieza más pesada	25 kg