

5 25 065 0110 0

eibe unique Instalación de juego Terion

made in germany

3+





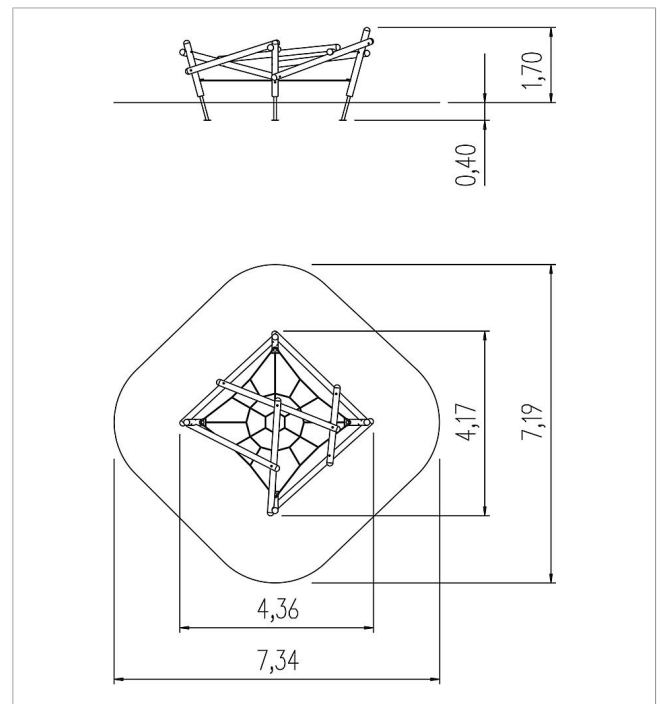

Volumen del suministro

Construcción de postes: madera de conífera

Bases de postes: acero galvanizado en caliente

redes: cable de acero cable de acero recubierto en pl rama ico



	Material	MadCAc
	Nivel fundamento	FL 1
	Espacio mínimo	615x615x325 cm
	Altura de caída libre	145 cm
	Prot. contra caídas neto	34,9 m ²
	Fundamentos	4x FHS ó 4x FPP