

5 25 090 0110 0

**eibe unique Columpio
cuádruple Águila con
asiento de nido**







made in germany

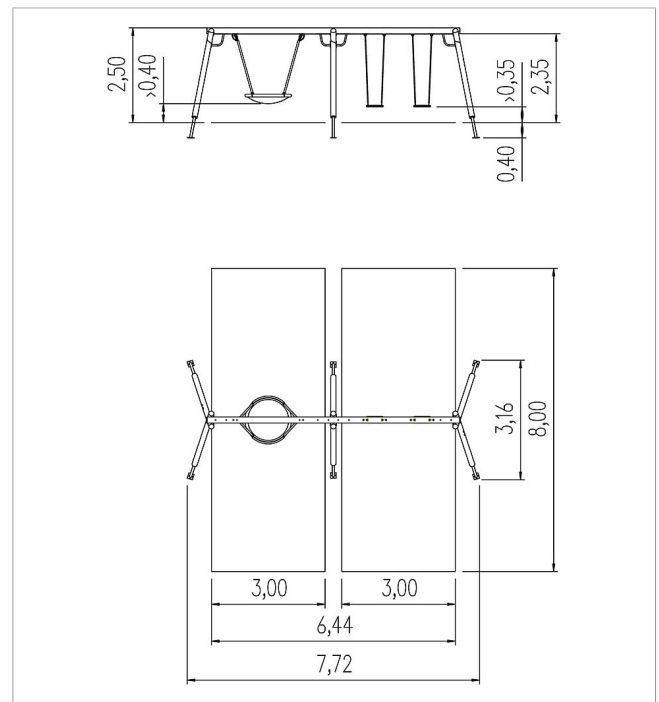

Volumen del suministro

- 1 armazon de columpio: MadC, acero galvanizado en caliente
- 2 asientos de columpio con cadenas: acero inoxidable, goma
- 1 asiento nido Ø 120 cm: anillo de cuerda, aceroseil-Gliedermatte, gomagewebe con suspensión cadenas
- juego de articulaciones cardan: acero galvanizado
- juego de articulaciones columpio: acero galvanizado
- bases de postes: acero galvanizado en caliente



	Material	MadCAc
	Nivel fundamento	FL 1
	Espacio mínimo	800x772x325 cm
	Altura de caída libre	200 cm
	Prot. contra caídas neto	50 m ²
	Fundamentos	6x FHS oder 6x FPP + 6x FHS
	Pieza más grande	650xØ 16 cm