

5 66 419 5

## eibe acqua estructura de de agua C1





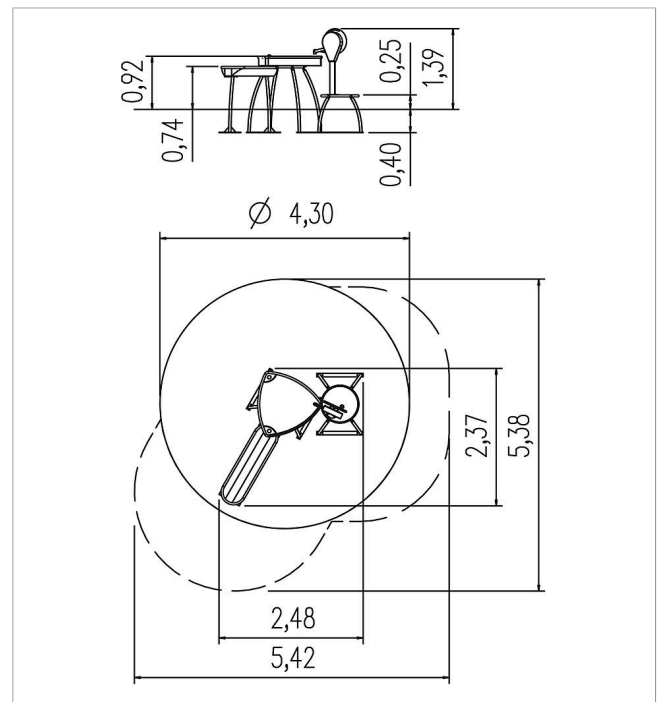

made in germany

3+

### Volumen del suministro

- 1 bomba de manivela: acero inoxidable
- 1 plataforma para bomba con revestimiento de goma :  
acero inoxidable, goma
- 1 canal de agua L 150 cm: acero inoxidable
- 1 cuenca de distribución: acero inoxidable
- 1 armazón para cuenca de barro Al 75 cm: acero inoxidable
- 2 patas para canales H 75 cm: acero inoxidable



	Material	acero inoxidable
	Nivel fundamento	FL 1
	Espacio mínimo	542x538x255 cm
	Altura de caída libre	75 cm
	Prot. contra caídas neto	14,5 m <sup>2</sup>
	Fundamentos	3x FHS ó 6x FPP