

5 56 066 0

**eibe fantallica Carrusel
de pie Venus Ø= 50 cm**







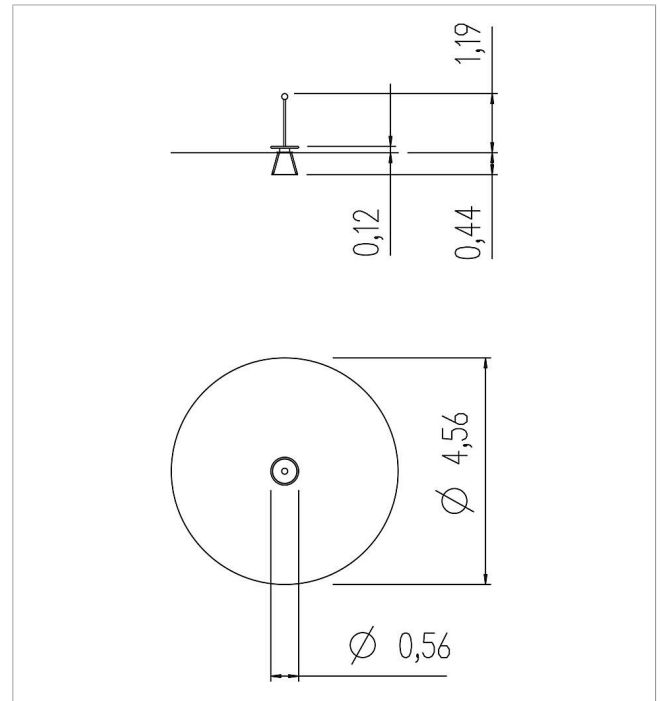

made in germany

3+

Volumen del suministro

- 1 placa de fijación: acero inoxidable
- 1 cojinete: acero inoxidable
- 1 placa de base D 50 cm: acero inoxidable, goma
- Construcción de base: acero inoxidable



	Material	Acero inoxidable
	Nivel fundamento	FL 3
	Espacio mínimo	Ø 456x312 cm
	Altura de caída libre	12 cm
	Prot. contra caídas neto	34 m ²
	Fundamentos	1x FHS
	Montaje	2 personas/2 h
	Pieza más grande	Ø 56x119 cm
	Pieza más pesada	9 kg