

5 67 219 0

**eibe fantallica Balancín  
de muelle Tumbona**







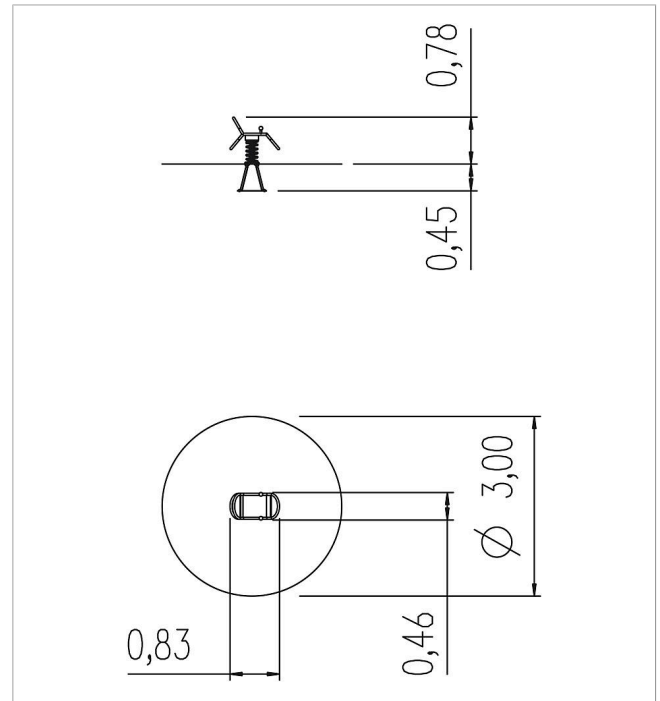

made in germany

3+

**Volumen del suministro**

- 1 armazón: acero inoxidable
- 1 muelle: acero para muelles



	Material	Acero inoxidable
	Nivel fundamento	FL 3
	Espacio mínimo	Ø 300x231 cm
	Altura de caída libre	51 cm
	Prot. contra caídas neto	7,5 m <sup>2</sup>
	Fundamentos	1x 5632280 + 1x FHS
	Montaje	1 persona/1 h
	Pieza más grande	83x46x54 cm
	Pieza más pesada	30 kg