

5 54 009 0

**eibe fantallica Estación
activa Espaldera**

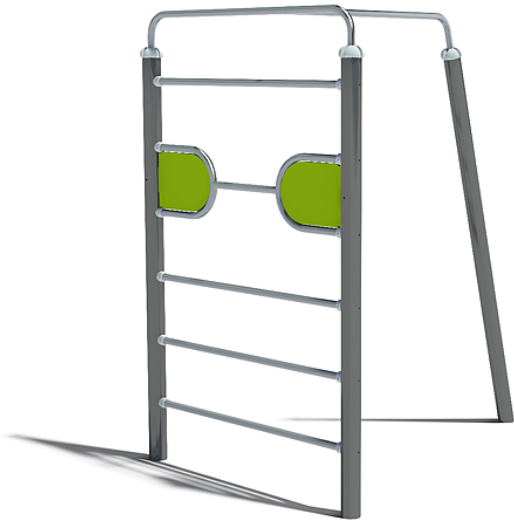





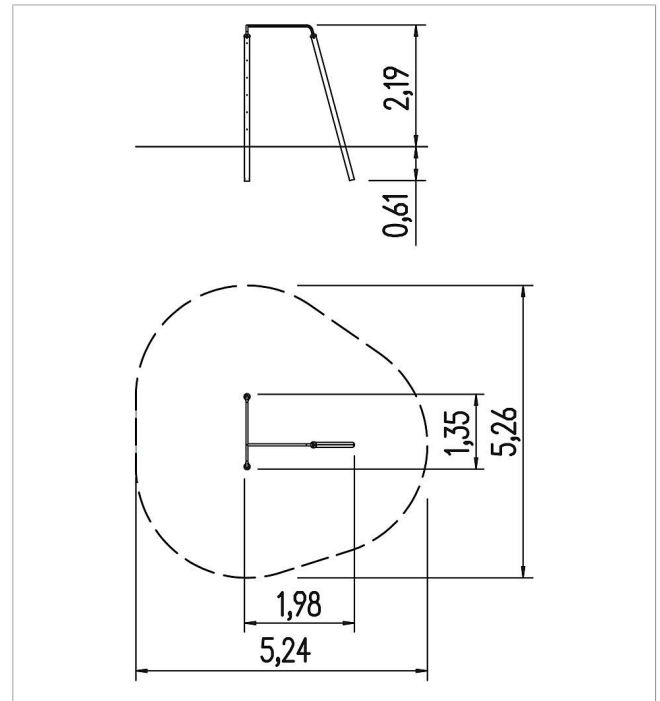

made in germany



Volumen del suministro

- 1 poste: acero galvanizado en caliente y recubierto en polvo
- 2 escaleras de peldaños: acero inoxidable, acero galvanizado en caliente y recubierto en polvo
- 2 barandas: HPL



	Material	Acero, HPL
	Nivel fundamento	FL 3
	Espacio mínimo	524x526x399 cm
	Altura de caída libre	220 cm
	Prot. contra caídas neto	27 m ²
	Fundamentos	3x FHS
	Montaje	-
	Pieza más grande	9x9x266 cm
	Pieza más pesada	35 kg