

5 54 003 0







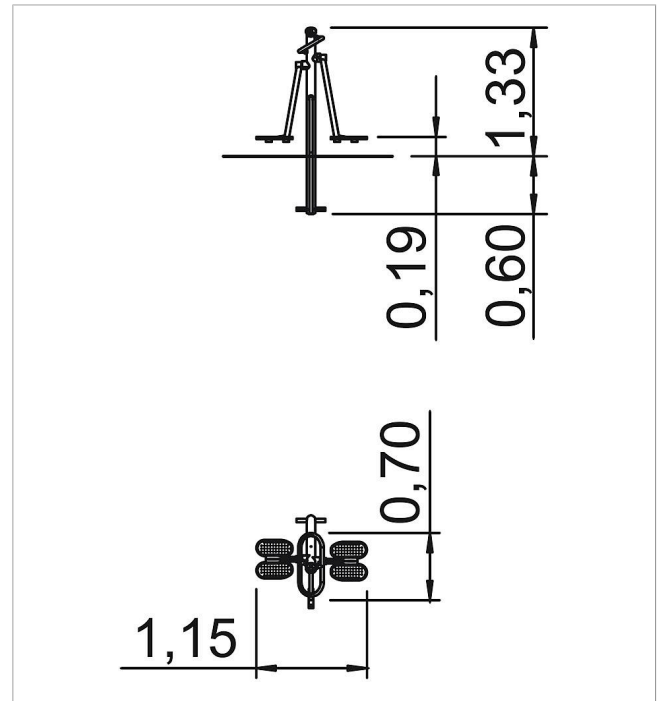

**eibe fantallica Estación  
activa Balanceo en  
paralelo**  
made in germany



**Volumen del suministro**

1 poste: acero galvanizado en caliente y recubierto en polvo  
2 soportes de pie: acero inoxidable  
1 baranda: HPL Tapas para postes: PA6



	Material	Acero, HPL
	Nivel fundamento	FL 3
	Espacio mínimo	115x70x203 cm
	Altura de caída libre	19 cm
	Prot. contra caídas neto	-
	Fundamentos	2x FHS
	Montaje	-
	Pieza más grande	9x9x194 cm
	Pieza más pesada	30 kg