

5 30 047 0

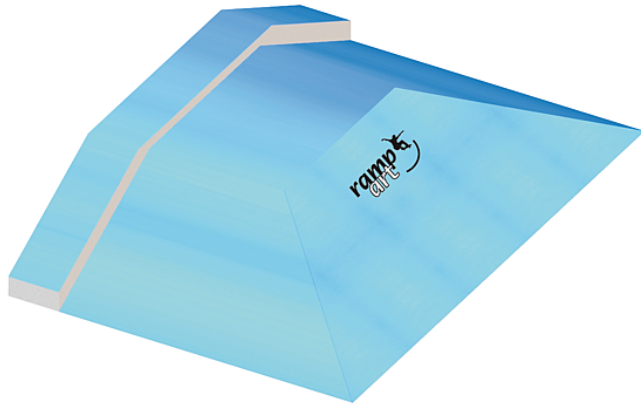





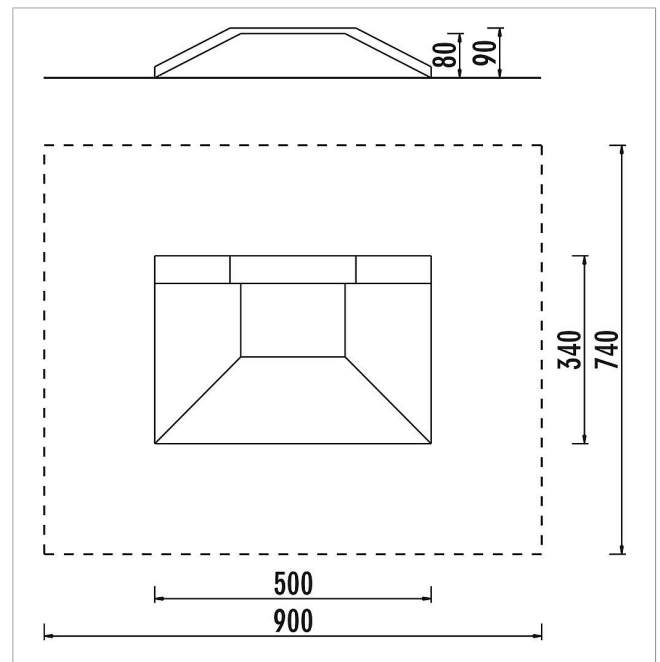

eibe rampart 1/2 Pyramide with wall

made in germany



Volumen del suministro



	Material	Acero, PRF
	Nivel fundamento	-
	Espacio mínimo	900x740x590 cm
	Altura de caída libre	-
	Prot. contra caídas neto	-
	Fundamentos	-
	Montaje	1 persona/3,5 h
	Pieza más grande	500x340x90 cm
	Pieza más pesada	900 kg