

5 10 134 0111 0

made in germany

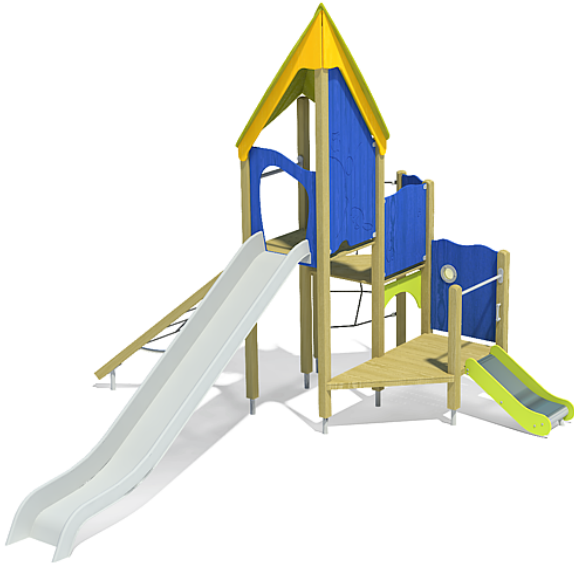

1+

Volumen del suministro

Juego de postes con pies de soporte: madera de conífera, acero galvanizado en caliente

Juego de plataformas: madera de conífera

Juego de barandas: madera de conífera, placa de tres capas

Tejado en punta: madera de conífera, placa de tres capas





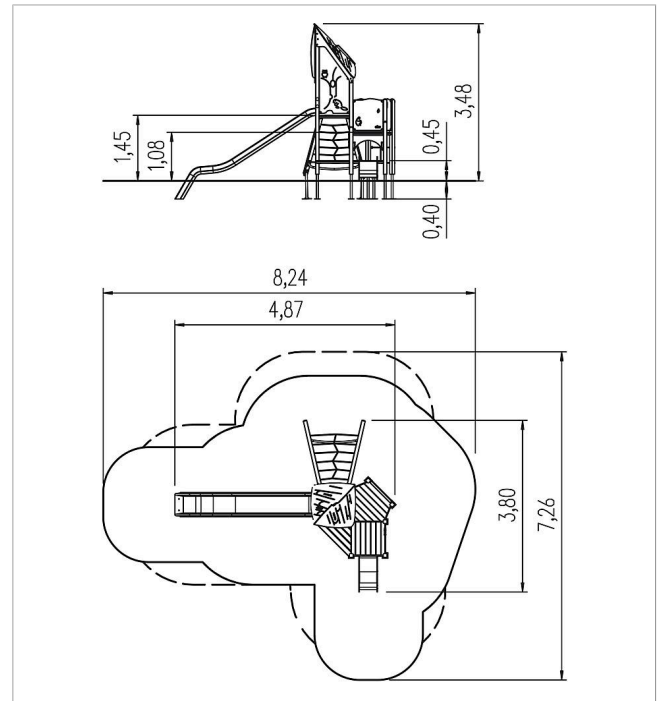

Red de subida: red cable de acero recubierto con plástico

Red de subida: red cable de acero recubierto con plástico

tobogán AP 145 cm: GRP

tobogán AP 45cm: HPL, acero inoxidable



	Material	MadCAc
	Nivel fundamento	FL 1
	Espacio mínimo	824x726x348 cm
	Altura de caída libre	145 cm
	Prot. contra caídas neto	33,7 m ²
	Fundamentos	13x FHS o 13x FPP