

5 55 118 0

eibe **Árbol de cuerdas**
Nido de águilas con
poste de metal

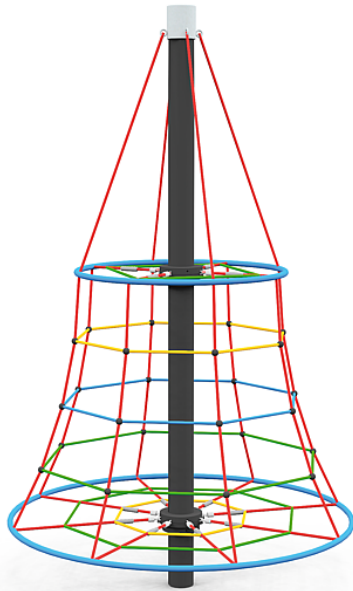





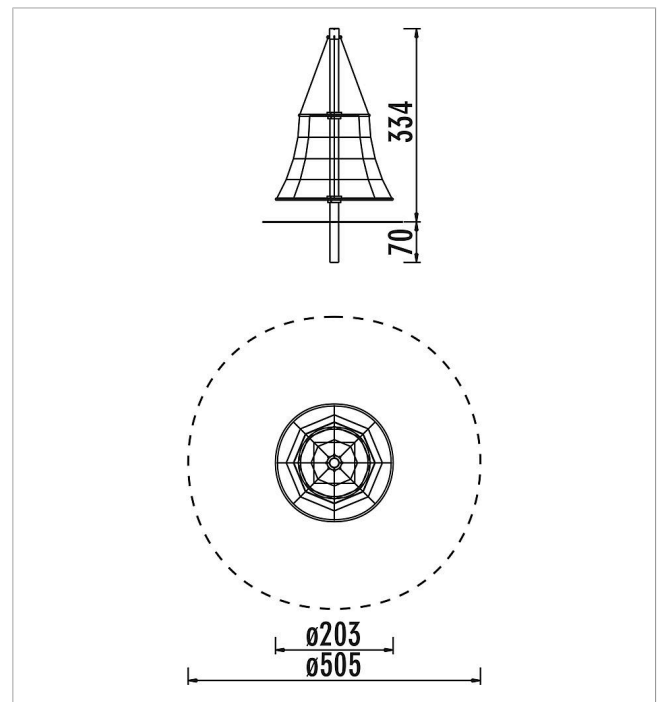

made in germany



Volumen del suministro

1 árbol de cuerdas Nido de águilas:
aluminio, cable de acero recubierto con plástico



	Material	Acero
	Nivel fundamento	FL 3
	Espacio mínimo	Ø 505x387 cm
	Altura de caída libre	187 cm
	Prot. contra caídas neto	21 m ²
	Fundamentos	1x FHS
	Montaje	2 personas/1,5 h
	Pieza más grande	Ø 15x400 cm
	Pieza más pesada	60 kg