

5 62 034 0

eibe Instalación de tenis de mesa redonda

made in germany









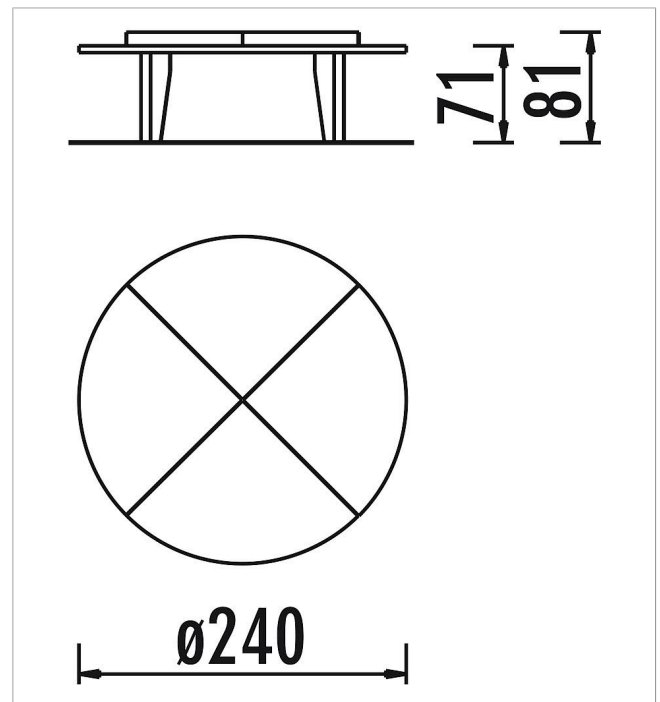

6+

Volumen del suministro

- 1 placa de tenis de mesa: hormigón polímero
- 1 juego de redes partidas en 4: acero inoxidable
- 4 patas de mesa: hormigón



	Material	Hormigón acrílico
	Nivel fundamento	FL 3
	Espacio mínimo	Ø 640x250 cm
	Altura de caída libre	-
	Prot. contra caídas neto	-
	Fundamentos	4x FHS
	Montaje	2 personas/1 h
	Pieza más grande	240x120x6 cm
	Pieza más pesada	130 kg