

5 40 105 1012 6

Tobogán ancho PRF AP 195 cm

made in germany

3+

Volumen del suministro

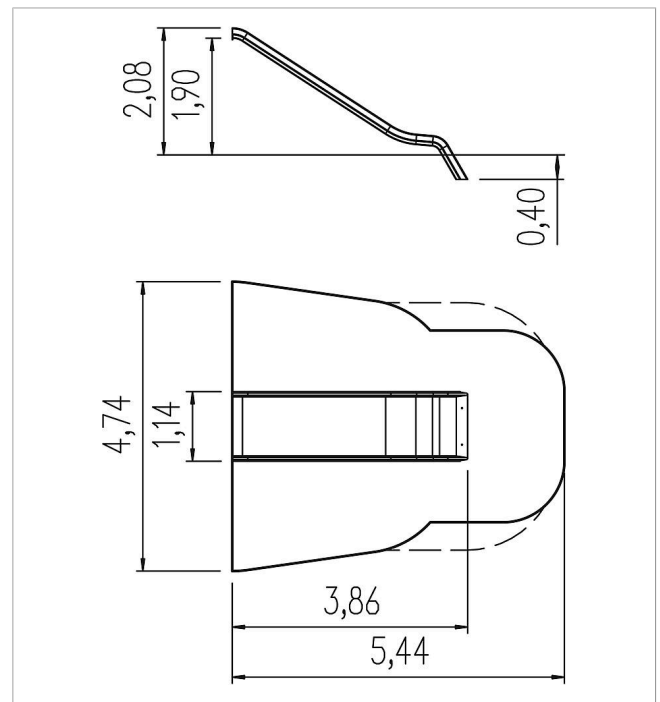

	Material	PRF
	Nivel fundamento	FL 1
	Espacio mínimo	544x474x370 cm
	Altura de caída libre	190 cm
	Prot. contra caídas neto	21 m ²
	Fundamentos	1x FHS o 1x FPP
	Montaje	2 personas/1 h
	Pieza más grande	459x114x45 cm
	Pieza más pesada	65 kg