

5 58 319 0

Tobogán adicional de tubo recto, AP 145 cm







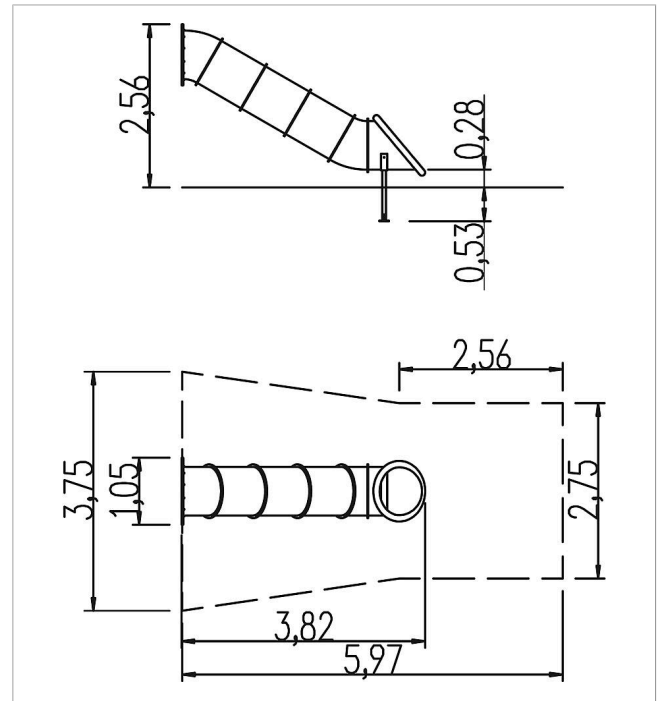

made in germany

3+

Volumen del suministro

1 tobogán adicional de tubo AP 145: PRF



	Material	PRF
	Nivel fundamento	FL 3
	Espacio mínimo	597x375x325 cm
	Altura de caída libre	30 cm
	Prot. contra caídas neto	18,5 m ²
	Fundamentos	1x FHS
	Montaje	2 personas/2,5 h
	Pieza más grande	Ø 84x80 cm
	Pieza más pesada	30 kg