

5 68 038 0

eibe Concha de mimbres

made in germany









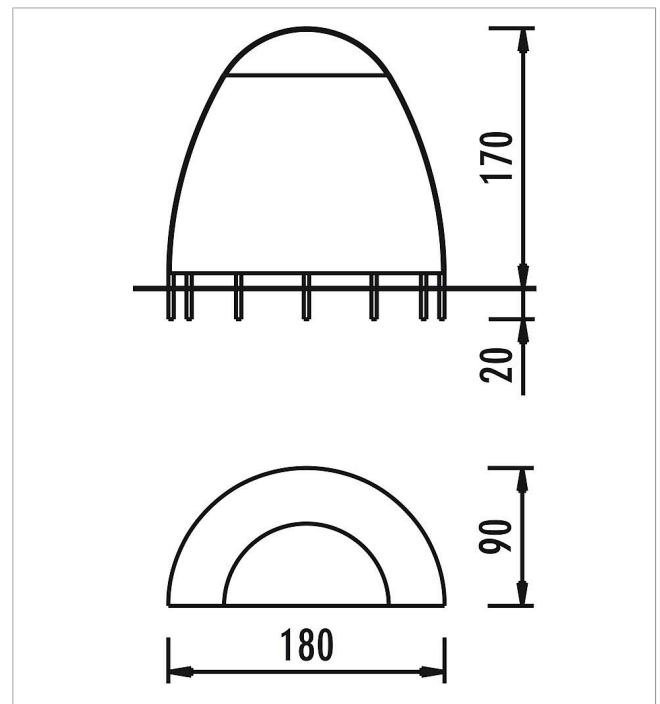

1+

Volumen del suministro

1 concha de mimbre: mimbre



	Material	Mimbres
	Nivel fundamento	-
	Espacio mínimo	180x90x180 cm
	Altura de caída libre	-
	Prot. contra caídas neto	-
	Fundamentos	-
	Montaje	-
	Pieza más grande	180x90x190 cm
	Pieza más pesada	10 kg